

KIWATEK

TAWA-T4805 4U RACKMOUNT

Dimensions:

481.80mm(W) x 448.8mm (D) x 176.6 mm (H) (18.9" x 17.6" x 7")

Motherboard Spec.

For 12"x13" SERVERBOARD
Support 7 port PCI card/PCI long card

Front Panel:

Power SW x 1 . Power LED x 1 . HDD LED x 1
USB(1x2) x 1 .

Drive bays:

INNER : 3.5" HDD x 5

Cooling Fan:

12 cm Fan x 3 (Front side)

Power Input:

PS2 POWER SUPPLY x 1

Construction:

Metal chassis
Low Operation temperature

RoHS Compliant

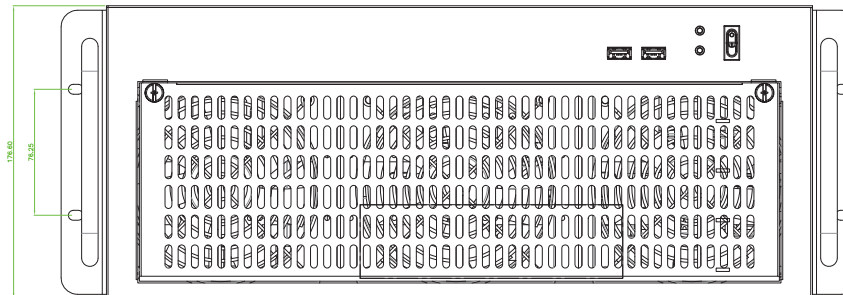
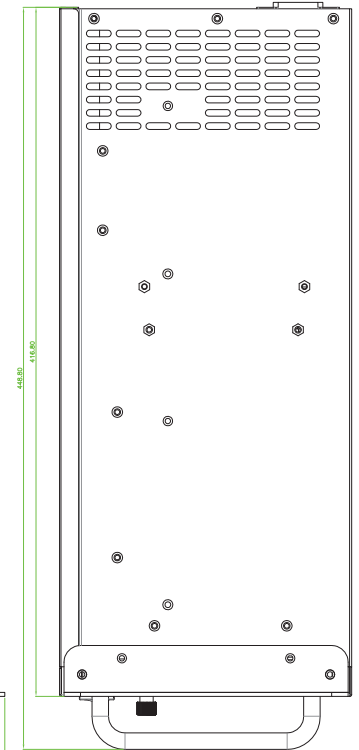
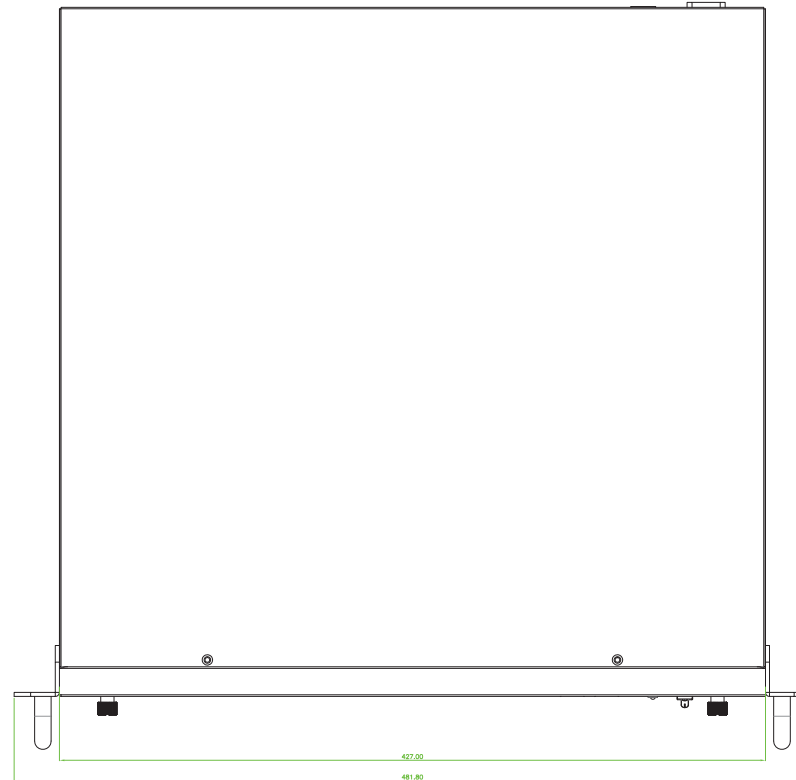
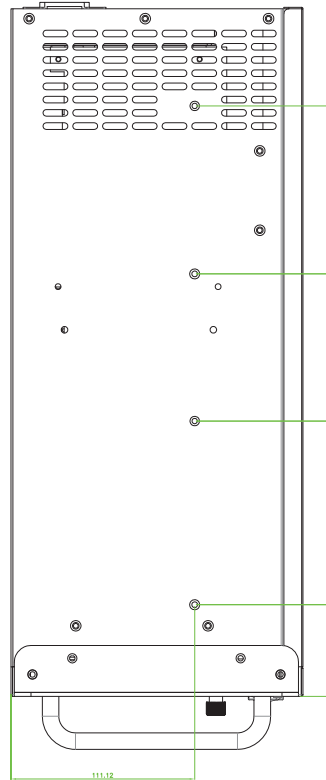
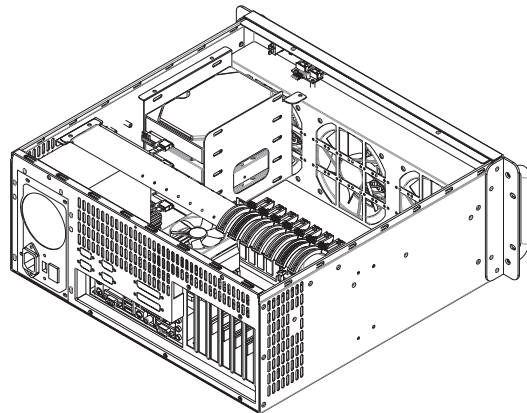
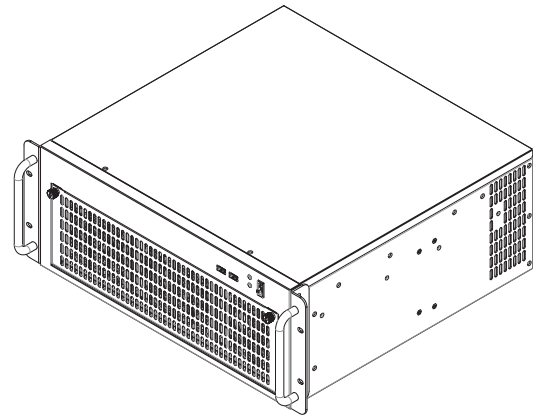
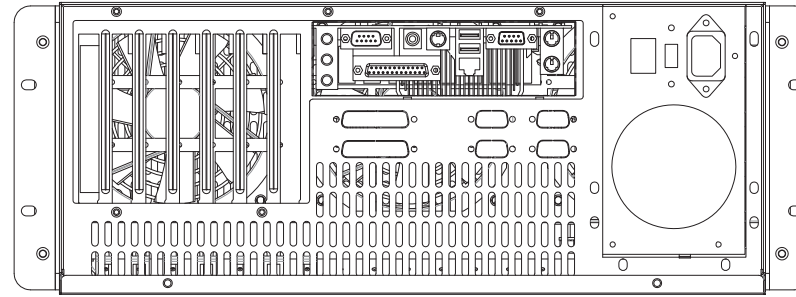

UNIT : mm
Rev : 1.0
Date : 2013.08.05